

Article: **NA G110AB-DN2**
Description: Modular prewired switch with plunger

Sheet: 32170-0-en-2.1.0
Date: 09/10/2023
Page: 1/4



Housing:

Metal housing, 20 mm fixing points
Protection degree: IP67 acc. to EN 60529, IP69K acc. to ISO 20653 (Protect the cables from direct high-pressure and high-temperature jets)

General data:







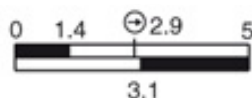

Corrosion resistance in saline mist: ≥ 300 hours in NSS according to ISO 9227
Max actuation frequency: 3600 operating cycles/hour
Mechanical endurance: 20 million operating cycles
B10D: 40,000,000 for NC contacts
Mechanical interlock, not coded: type 1 according to EN ISO 14119

Contact block characteristics:

Contact block	Contact diagram	Contact design	Operation type	Positive opening	Contact type	Captive screws	Terminals with finger protection	Gold-plated contacts 1 μ m	
G11	1NO+1NC		Zb	slow action	yes	Double interruption	/	/	yes

Contact block travel diagrams:



	Closed contact		Switch pressed
	Open contact		Switch released
	Positive opening travel (EN 60947-5-1)		Reset engagement travel
	Opening travel 2 x 2 mm (EN 81)		Mechanical switching point

Positive switch opening:

Device with positive opening conforming to IEC 60947-5-1.

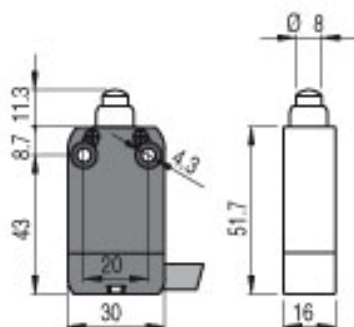

Device screw tightening torques:

Head screws: 0.5 ... 0.7 Nm
Lever screw: 0.8 ... 1.2 Nm
Connector screw: 0.3 ... 0.6 Nm
M4 fixing screws, body: 2 ... 3 Nm

Activating forces:

Min.: 7 N
Positive opening: 25 N

In conformity with standards:

IEC 60947-5-1, EN 60947-5-1, IEC 60204-1, EN 60204-1, EN ISO 14119, EN ISO 12100, IEC 60529, EN 60529, EN 50581, ISO 20653, UL 508, CSA 22.2 No.14.

In conformity with requirements requested by:

Low Voltage Directive 2014/35/EU, EMC Directive 2014/30/EU, RoHS Directive 2011/65/EU.

Markings and quality marks:



Electrical data:

Rated impulse withstand voltage (U_{imp}): 4 kV
Conditional short circuit current: 1000 A according to EN 60947-5-1
Pollution degree: 3

Important: Switch off the circuit voltage before disconnecting the connector from the switch. The connector is not suitable for separation of electrical loads. According to EN 60204-1, 2NO+2NC versions with 8-pin M12 and AMP connector can be used only in PELV circuits.

Internal connections:

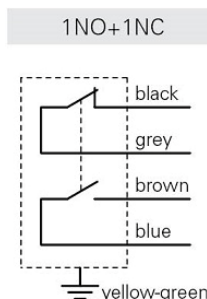

Article: **NA G110AB-DN2**
Description: Modular prewired switch with plunger

Sheet: 32170-0-en-2.1.0
Date: 09/10/2023
Page: 2/4

Utilization temperatures and electrical data:

	Connection type	Output with cable								Output with M12 connector		Output with AMP connector
		2 contacts				3 contacts		4 contacts		2 contacts	3 or 4 contacts	2 contacts
		E	N	H	R	N	H	N	R	M12 connector, 5-pole	M12 connector, 9-pole	AMP Super-seal 1.5 connector
Cable features	Cable or connector type	5x0.75 mm ²	5x0.75 mm ²	5x0.75 mm ²	5x0.5 mm ²	7x0.5 mm ²	7x0.5 mm ²	9x0.34 mm ²	9x0.5 mm ²	5x0.25 mm ²	8x0.25 mm ²	
	Application field	General	General	General, mobile installation	Rail	General	General, mobile installation	General	Rail	General	General	General
	In compliance with standards	H05VV-F	H05VV5-F	05EQ-H	EN50306-4 IEC 300V 5x0.5 mm ² MM-90 EN 50306-4 EN 45545	03VV-F	03EQ-H	03VV-F	EN50306-4 TP-300V 9x0.5 mm ² MM-90 EN 50306-4 EN 45545	03VV-H	03VV-H	/
	Sheath	PVC	PVC OIL RESISTANT	PUR HALOGEN FREE	/	PVC OIL RESISTANT	PUR HALOGEN FREE	PVC OIL RESISTANT	/	PVC OIL RESISTANT	PVC OIL RESISTANT	/
	Self-extinguishing	IEC 60332-1-2	IEC 60332-1-2 UL 758:FT1 CEI 20-22 II	IEC 60332-1-2 UL 758:FT1	IEC 60332-1 EN 50305 EN 50306-1	IEC 60332-1-2 UL 758:FT1 CEI 20-22 II	IEC 60332-1-2 UL 758:FT1	IEC 60332-1-2 UL 758:FT1 CEI 20-22 II	IEC 60332-1 EN 50305 EN 50306-1	IEC 60332-1-2 CEI 20-22 II UL 758:FT1	IEC 60332-1-2 CEI 20-22 II UL 758:FT1	/
	Oil resistant	/	UL 758 CSA 22.2 N°210	UL 758 CSA 22.2 N°210	/	UL 758 CSA 22.2 N°210	UL 758 CSA 22.2 N°210	UL 758 CSA 22.2 N°210	/	UL 758 CSA 22.2 N°210	UL 758 CSA 22.2 N°210	/
	Max. speed	/	/	300 m/min	/	/	300 m/min	/	/	50 m/min	50 m/min	/
	Max. acceleration	/	/	30 m/s ²	/	/	30 m/s ²	/	/	5 m/s ²	5 m/s ²	/
	Minimum bending radius	80 mm	80 mm	80 mm	60 mm	108 mm	80 mm	108 mm	65 mm	75 mm	90 mm	/
	Outer diameter	8 mm	8 mm	8 mm	6 mm	7 mm	7 mm	7 mm	6.5 mm	6 mm	6 mm	/
	End stripped	80 mm	80 mm	80 mm	80 mm	80 mm	80 mm	80 mm	80 mm	/	/	/
	Copper conductors IEC 60228	Class 5	Class 5	Class 6	Class 5	Class 5	Class 6	Class 5	Class 5	Class 6	Class 6	/
	Engraving	Standard	6268	6280	Standard	6274	6282	6278	Standard	6267	6275	/
Ambient temperature with cable extended (T₁₆) standard	Cable, fixed installation	-15°C +60°C	-25°C +80°C	-25°C +80°C	-25°C +80°C	-25°C +80°C	-25°C +80°C	-25°C +80°C	-25°C +80°C	-25°C +80°C	-25°C +80°C	/
	Cable, flexible installation	+5°C +60°C	-5°C +80°C	-25°C +80°C	-25°C +80°C	-5°C +80°C	-25°C +80°C	-5°C +80°C	-25°C +80°C	-15°C +80°C	-15°C +80°C	/
	Cable, mobile installation	/	/	-25°C +80°C	/	/	-25°C +80°C	/	/	-15°C +80°C	-15°C +80°C	/
	Cable, fixed installation	/	/	-40°C +80°C	-40°C +80°C	/	-40°C +80°C	/	-40°C +80°C	/	/	/
	Cable, flexible installation	/	/	-40°C +80°C	-40°C +80°C	/	-40°C +80°C	/	-40°C +80°C	/	/	/
	Cable, mobile installation	/	/	-40°C +80°C	/	/	-40°C +80°C	/	/	/	/	/
Electrical data	Thermal current I _{th}	10 A	10 A	10 A	6 A	6 A	6 A	3 A	4 A	4 A	2 A	10 A
	Rated insulation voltage U _i	250 Vac	250 Vac	250 Vac	250 Vac	250 Vac	250 Vac	250 Vac	250 Vac	250 Vac 300 Vdc	30 Vac 36 Vdc	30 Vac
	Protection against short circuits (fuse)	10 A 500 V type gG	10 A 500 V type gG	10 A 500 V type gG	6 A 500 V type gG	6 A 500 V type gG	6 A 500 V type gG	3 A 500 V type gG	4 A 500 V type gG	4 A 500 V type gG	2 A 500V type gG	10 A 500 V type gG
	Utilization category DC13	24 V	2 A	2 A	2 A	2 A	2 A	2 A	2 A	2 A	2 A	2 A
		125 V	0.4 A	0.4 A	0.4 A	0.4 A	0.4 A	0.4 A	0.4 A	0.4 A	0.4 A	/
		250 V	0.3 A	0.3 A	0.3 A	0.3 A	0.3 A	0.3 A	0.3 A	0.3 A	0.3 A	/
	Utilization category AC15	24 V	4 A	4 A	4 A	4 A	4 A	3 A	4 A	4 A	2 A	4 A
		120 V	4 A	4 A	4 A	4 A	4 A	3 A	4 A	4 A	/	/
		250 V	4 A	4 A	4 A	4 A	4 A	3 A	4 A	4 A	/	/
	Approvals	CE cULus IMQ EAC CCC	CE cULus IMQ EAC CCC	CE cULus IMQ EAC CCC	CE IMQ EAC CCC	CE cULus IMQ EAC CCC	CE cULus IMQ EAC CCC	CE cULus IMQ EAC CCC	CE IMQ EAC CCC	CE cULus IMQ EAC CCC	CE cULus EAC	CE cULus EAC

Article: **NA G110AB-DN2**
Description: Modular prewired switch with plunger

Sheet: 32170-0-en-2.1.0
Date: 09/10/2023
Page: 3/4

Characteristics approved by IMQ

Rated insulation voltage (Ui): 250 Vac
Conventional free air thermal current (Ith): 10 A (1-2 contacts) / 6 A (2-3 contacts) / 4 A (4 contacts or 5-pin M12 connector)
Protection against short circuits (fuse): 10 A (1-2 contacts) / 6 A (2-3 contacts) / 4 A (4 contacts or 5-pin M12 connector), gG type
Rated impulse withstand voltage (Uimp): 4 kV
Protection degree of the housing: IP67
MA terminals (saddle clamps)
Pollution degree: 3
Utilization category: AC15 / DC13 (with connector)
Operating voltage (Ue): 250 Vac (50 Hz) / 24 Vdc (with connector)
Operating current (Ie): 3 A / 2 A (with connector)
Forms of the contact element: X, Y, X+Y, X+X, Y+Y, Y+Y+X, X+X+Y, X+X+Y+Y, Zb
Positive opening of contacts on contact blocks B01, B11, B02, B12, B21, B22, G01, G11, G02, G12, G21, G22, L01, L11, L02, L12, L21, L22, H01, H11, H02, H12, H21, H22
In conformity with standards: EN 60947-1, EN 60947-5-1 + A1:2009, fundamental requirements of the Low Voltage Directive 2006/95/EC.

Characteristics approved by UL

Electrical Ratings:
R300 pilot duty (28 VA, 125 250 Vdc)
B300 pilot duty (360 VA, 120 240 Vac) (1 cont.)
B300 pilot duty (360 VA, 120 240 Vac) (2 - 3 cont. without connector)
C300 pilot duty (180 VA, 120 240 Vac) (2 - 3 cont. with connector)
C300 pilot duty (180 VA, 120 240 Vac) (4 cont.)

Environmental Ratings:

Types 1, 4X, 6, 12, 13
Types 1, 4X "indoor use only" (1 - 2 cont. with "E" type cable)

Screws torque of the detachable connector housing nominal are 0.3 + 0.6 Nm.

Mechanical stop

Acc. to EN ISO 14119 paragraph 5.2 "the position sensors must not be used as mechanical stop".

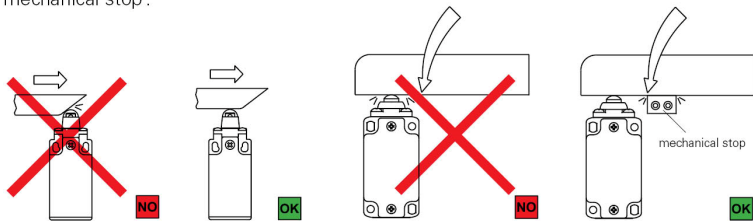

The actuator must not exceed the max. travel as indicated in the travel diagrams.

The guard must not use the switch head as a mechanical stop.

Actuation speed

Vmax (m/s)	Vmin (mm/s) L	Vmin (mm/s) R
0,5	1	0,01

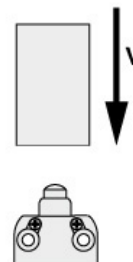



Contacts type:

R = snap action
L = slow action

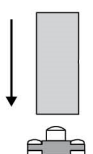
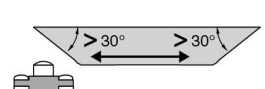
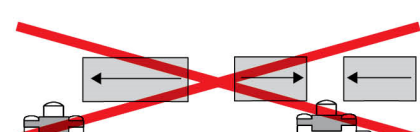
Actuation modes

Recommended application	Application to avoid This application is possible, but increased mechanical stress may shorten the operating life of the switch	Forbidden application
		

Installation of single switches with safety functions

- Use **only** switches with the symbol .
- Connect the safety circuit to **the NC normally closed contacts (11-12, 21-22 or 31-32).**
- **The NO normally open contacts (13-14, 23-24, 33-34) should be used only for signalling;** these contacts are not to be connected with the safety circuit. However, if two or more switches are used on the same guard, a connection can be established between the NO contacts and the safety circuit.
In this case at least one of the two switches must have positive opening and a normally closed contact NC (11-12, 21-22 or 31-32) must be connected to the safety circuit.
- Actuate the switch **at least up to the positive opening travel** shown in the travel diagrams with symbol .
- The actuation system must be able to exert a force that is greater than the **positive opening force**, as specified in brackets below each article, next to the minimum force value.
- The device must be affixed in compliance with EN ISO 14119.

Whenever the machine guard is opened and during the whole opening travel, **the switch must be pressed directly** (fig. 1) **or through a rigid connection** (fig. 2).

Only in this way the positive opening of the normally closed NC contacts (11-12, 21-22, 31-32) is guaranteed.

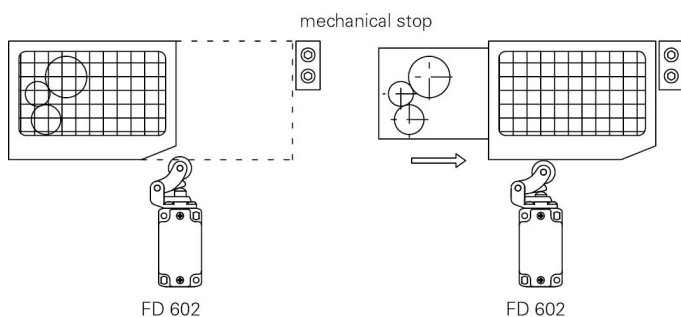

Fig.1

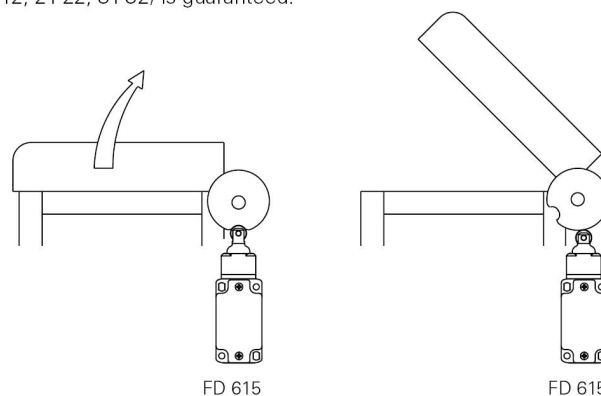

Fig.2

In safety applications with only one switch for each guard, the switches **must never be activated by a release** (fig. 3 and 4) **or through a non rigid connection** (i.e. by a spring).

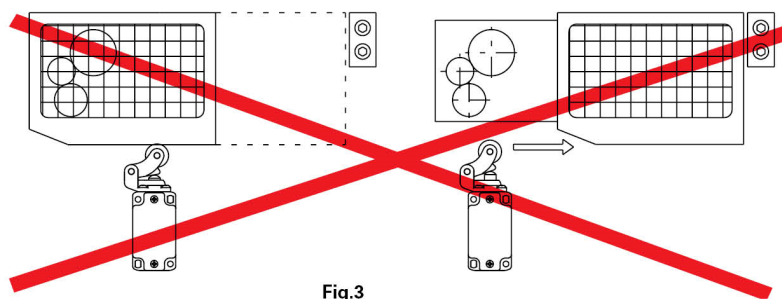

Fig.3

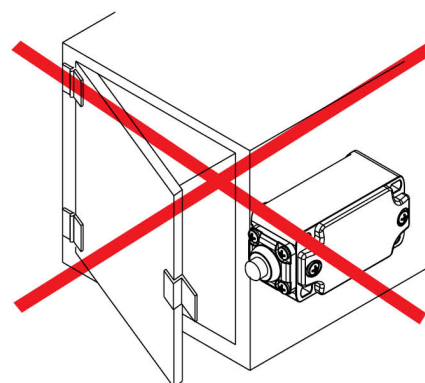

Fig.4