

PA 11 A 301T

Photoelectric Amplifier

Remote Photoelectric Systems



Product Data	
Function	Amplifier
Supply Voltage	115 V ac
Sensing Range	70 m
Output	Relay and NPN
Timer	On/Off Delay
Sensitivity Adjustment	Manual
Housing	11-pole DIN socket

Technical Data	
Supply Voltage	115 V ac
Voltage Tolerance	+/- 15 %
Current Consumption	Max. 3,5 VA
Response Time t_{on} / t_{off} , Relay	35 ms / 35 ms
Response Time t_{on} / t_{off} , Transistor	25 ms / 25 ms
Output, Relay	1 open/1 close, 250 V ac/3 A, 120 V ac/5 A
Output, Transistor	60 mA / 30 V dc
Power On Indicator	Green LED
Output Indicator	Yellow LED
LR Sensor Failure Indicator	Red LED
LT Sensor Failure Indicator	Red LED
Signal Level Indicator	Green LED
Sensor Monitor LED Drive	Green LED on the receiver: 'Power ON' Yellow LED on the transmitter: PA 11 output activated
Hysteresis	Approx. 45 %
Operation Frequency, Relay	14 Hz
Operation Frequency, Transistor	20 Hz
Delay Time t_{on} / t_{off}	0 – 10 sec, adjustable
Housing Material	Noryl

Environmental Data

Operation Temperature	- 10 to +50 °C
Storage Temperature	- 40 to +80 °C
Sealing Class	IP 40

Approvals



Wiring Diagram

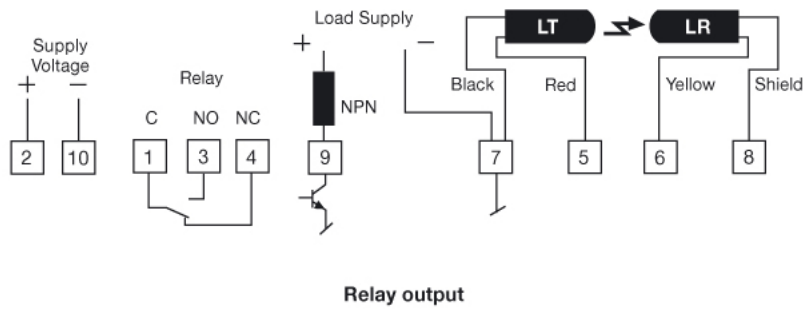

Dimensions

