

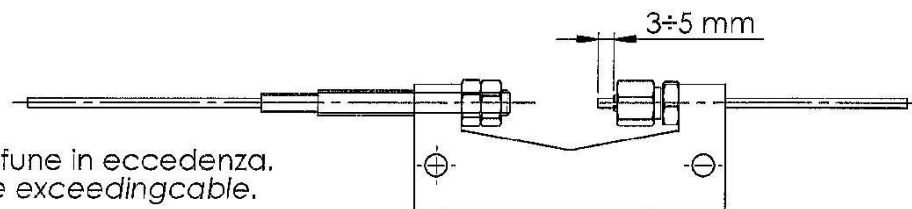

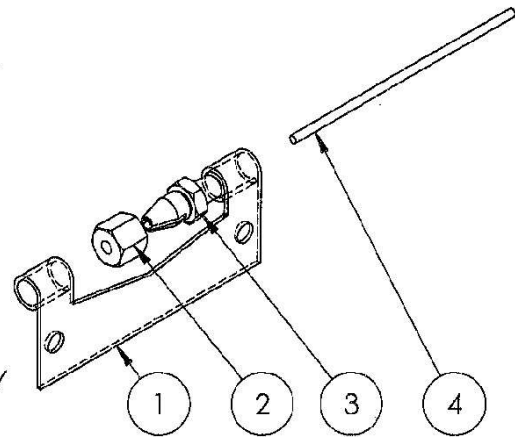

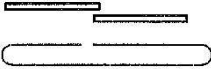

- 1 - Punto di ancoraggio - Anchor point
- 2 - Dado - Nut
- 3 - Perno filettato - Threaded pin
- 4 - Fune - Cable

Dopo aver tensionato la fune,
avvitare il dado con forza sul perno.
After cable tensioning screw powerfully
the nut on the threaded pin.

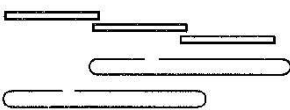
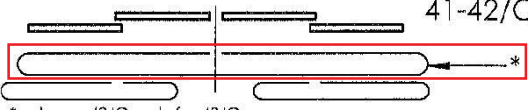

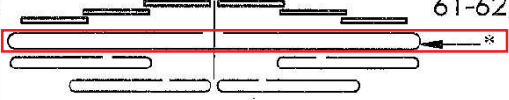
SCHEMA TIPOLOGIA FUNI - CABLE TYPE DIAGRAM

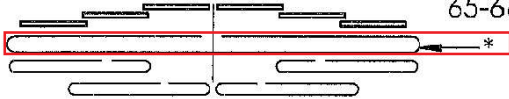
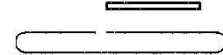
	11-12/R-L		01-02/C
	31-32/R-L		41-42/C
	33-35/R-L		43-44/C
	61-62/C		63/C
	65-66/R		72/R-L

*Av säkerhetsskäl SKALL skarvningen INTE användas i dessa fall.. /

*Due to safety reasons the cable tightening CAN NOT be used in these cases. /

* Aus Sicherheitsgründen sollte die Seilenverschraubung in diesen Fällen NICHT verwendet werden.