

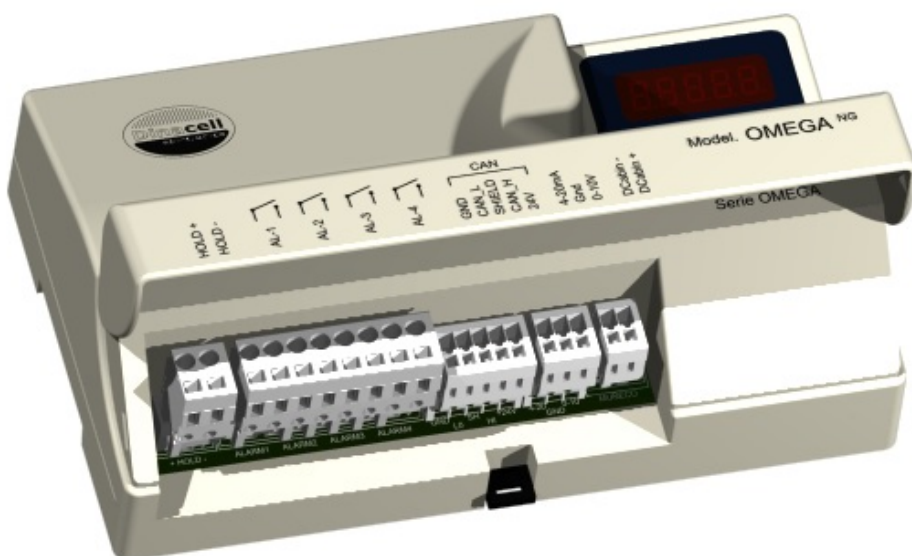

# OMEGA<sup>NG</sup>

## LOAD WEIGHING DEVICE

### User manual



# INDEX

<b>1. DESCRIPTION AND MAIN FEATURES .....</b>	<b>3</b>
<b>2. DISPLAY AND CONTROL BUTTONS.....</b>	<b>3</b>
<b>3. DIMENSIONS, INSTALLATION AND CONNECTIONS .....</b>	<b>4</b>
<b>4. MENU STRUCTURE .....</b>	<b>5</b>
<b>5. HOW TO VISUALIZE OR CHANGE PARAMETERS.....</b>	<b>6</b>
<b>6. DEVICE INFO .....</b>	<b>7</b>
<b>7. SYSTEM CONFIGURATION .....</b>	<b>8</b>
<b>8. ALARMS CONFIGURATION.....</b>	<b>10</b>
<b>9. CHAIN COMPENSATION .....</b>	<b>12</b>
9.1. New Chain Compensation .....	12
9.2. Submenu Chain.....	12
9.3. Chain Compensation Adjust .....	13
9.3.1. Software Compensation .....	13
9.3.2. Hardware Compensation .....	13
9.3.3. Auto-Zeroing Compensation.....	14
<b>10. ADDITIONAL FUNCTIONS .....</b>	<b>15</b>
10.1. Hold function.....	15
10.2. Analog output ( <i>Optional</i> ).....	15
10.3. Cabin Display ( <i>Optional</i> ).....	16
<b>11. CANOPEN PARAMETERS (<i>ONLY RELEVANT FOR OMEGA-C MODELS</i>).....</b>	<b>16</b>
<b>12. ERROR CODES AND TROUBLESHOOTING .....</b>	<b>18</b>
<b>13. ELECTRICAL SPECIFICATIONS .....</b>	<b>18</b>
<b>14. NG CONECTION .....</b>	<b>19</b>
14.1. Wifi NG Connection .....	19
14.2. Firmware Update .....	19
<b>15. WIRE ROPE TENSION EQUALAZING .....</b>	<b>20</b>
15.1 Wire Rope Tension checking Tool.....	20
15.2 Assistance to the wire rope tension adjustment.....	21
<b>16. QUICK CONFIGURATION GUIDE .....</b>	<b>23</b>

## 1. DESCRIPTION AND MAIN FEATURES

**OMEGA<sup>NG</sup>** Unit control is a Load Weighing device of the (NG) New Generation units from Dinacell Electronic with CanOpen-Lift CIA 417 Integrated.

The Main features of this unit are:

- **Measures, monitors and limits load in elevators.**
- **Up to 12 Individual Rope Tension monitoring.**
- **Wire Rope Tension adjustment.**
- **5 Digits display with 4 LEDs for alarm indication and 2 LEDs for Can Status**
- **Hold Input**
- **4 Alarms Thresholds (Full Load, Over Load, Zero Cabin, Slack Rope Tension )**
- **4 Relays output**
- **0-10v Analog Output**
- **4-20ma Analog Output**
- **Cabin Display Output**
- **CanOpen-Lift CiA 417.**
- **Software Chain compensation.**
- **Hardware Chain compensation.**

And the new features of Our NG devices

- **Remote WIFI Programming( NG )**
- **USB connection for firmware upgrading.**

## 2. DISPLAY AND CONTROL BUTTONS

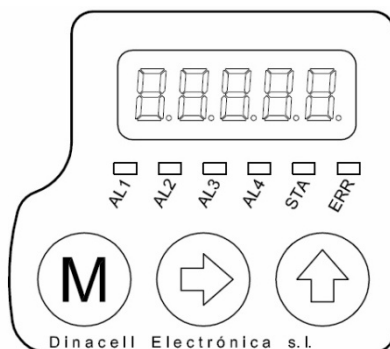

Functions of control buttons:

The unit is equipped with a menu by which the individual setting parameters can be displayed or modified.



- a. By Pressing this key for 2 Seconds Enter/exit the menu
- b. By Pressing this key inside the menus will navigate through parameters.
- c. Accept and save modified values when modifications are on progress.



- a. During menu navigation: Enter to modify a parameter.
- b. While modifying a parameter: Chose digit to change.

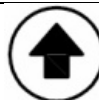

- a. During menu navigation: Show the stored value of the selected parameter.
- b. While modifying a parameter: Change the blinking digit incrementally from 0 to 9.

**Note:** After two minutes without any operation, the unit automatically returns to the total weight measure display, independent of the menu item previously selected.

Led	Functions
AL1	Full Load Alarm Indicator
AL2	Over Load Alarm Indicator
AL3	Zero Load Level Indicator (Empty Cabin)
AL4	Slack Rope tension indicator
STA	Led status ( For CanOpen: Status Led )
ERR	Error ( For CanOpen: Error Led)

### 3. DIMENSIONS, INSTALLATION AND CONNECTIONS

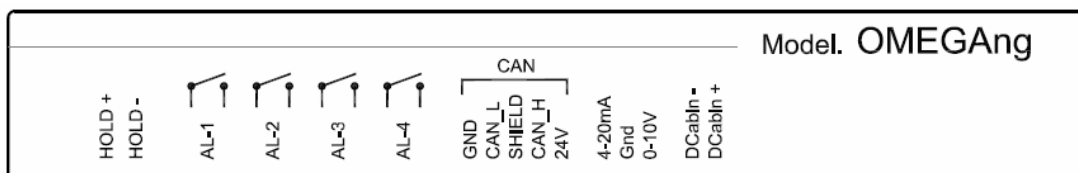
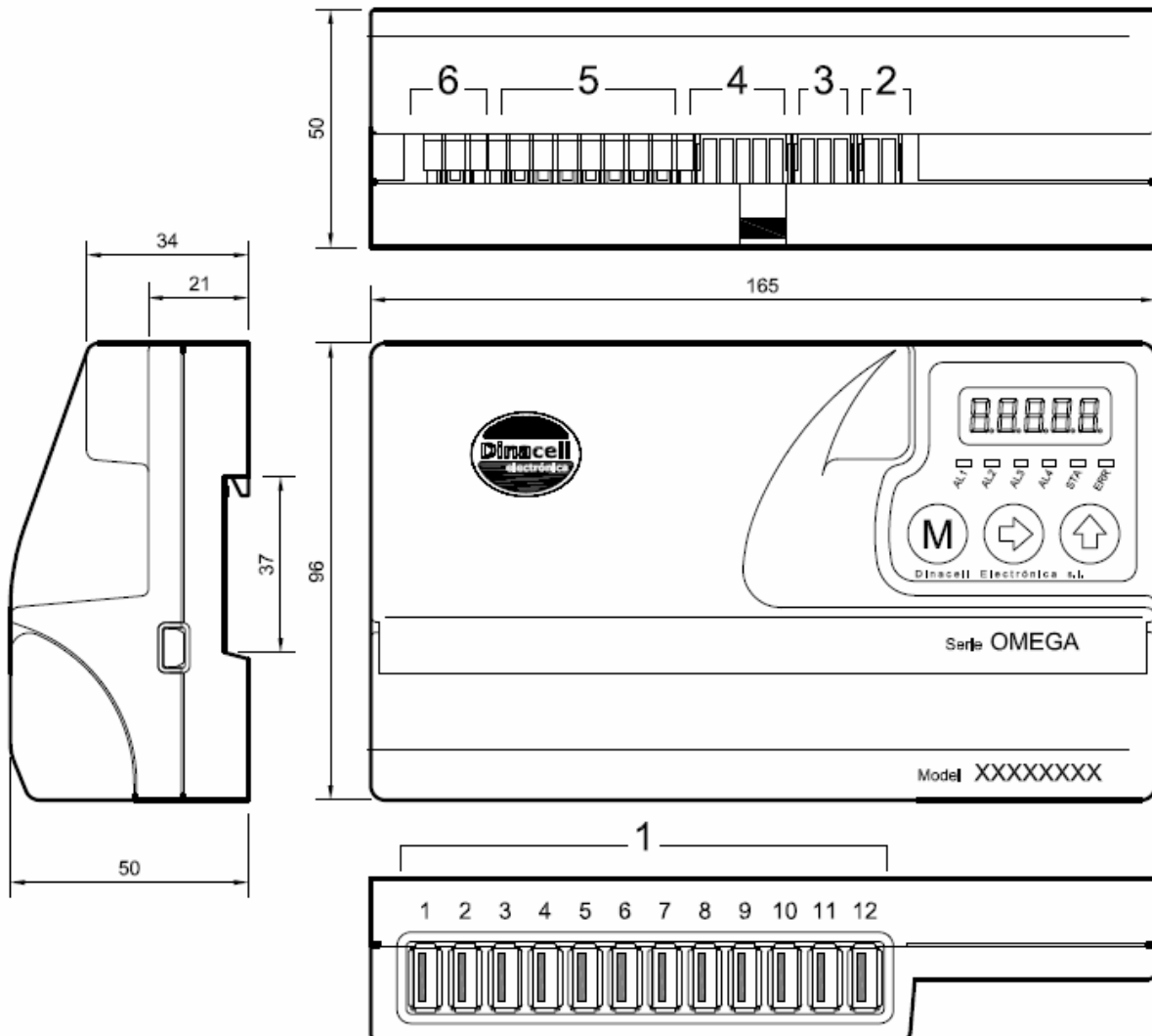

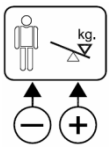
1	<b>Sensor inputs</b>	Up to 12 USB Connectors for easy plugging
2	<b>Cabin display output</b>	<p><b>Output</b> It provides two types of output:</p> <p>INC: Progressive display MB-D (two wire connection without polarity).</p> <p>LED: If overload, it will be an intermittent voltage of 5V (max. 30mA) with the polarity shown in the figure.</p> 
3	<b>Analog outputs</b>	This output reflects the sensors signal over the range 0-10V and 4-20mA. Common signal is GND. (See the ADDITIONAL FUNCTIONS chapter).
4	<b>Can Open</b>	<b>Input 24 VDC</b> power supply and Can Bus in an Open Style connector
5	<b>Relay connections for alarms</b>	Terminals of the alarm relays. (See the alarms section in chapter 8)
6	<b>HOLD input</b>	This function will be activated if an input voltage from 24 to 230V (DC or AC) is applied. (See the ADDITIONAL FUNCTIONS chapter).

## 4. MENU STRUCTURE

The menu has the cyclic structure shown in the following figure.



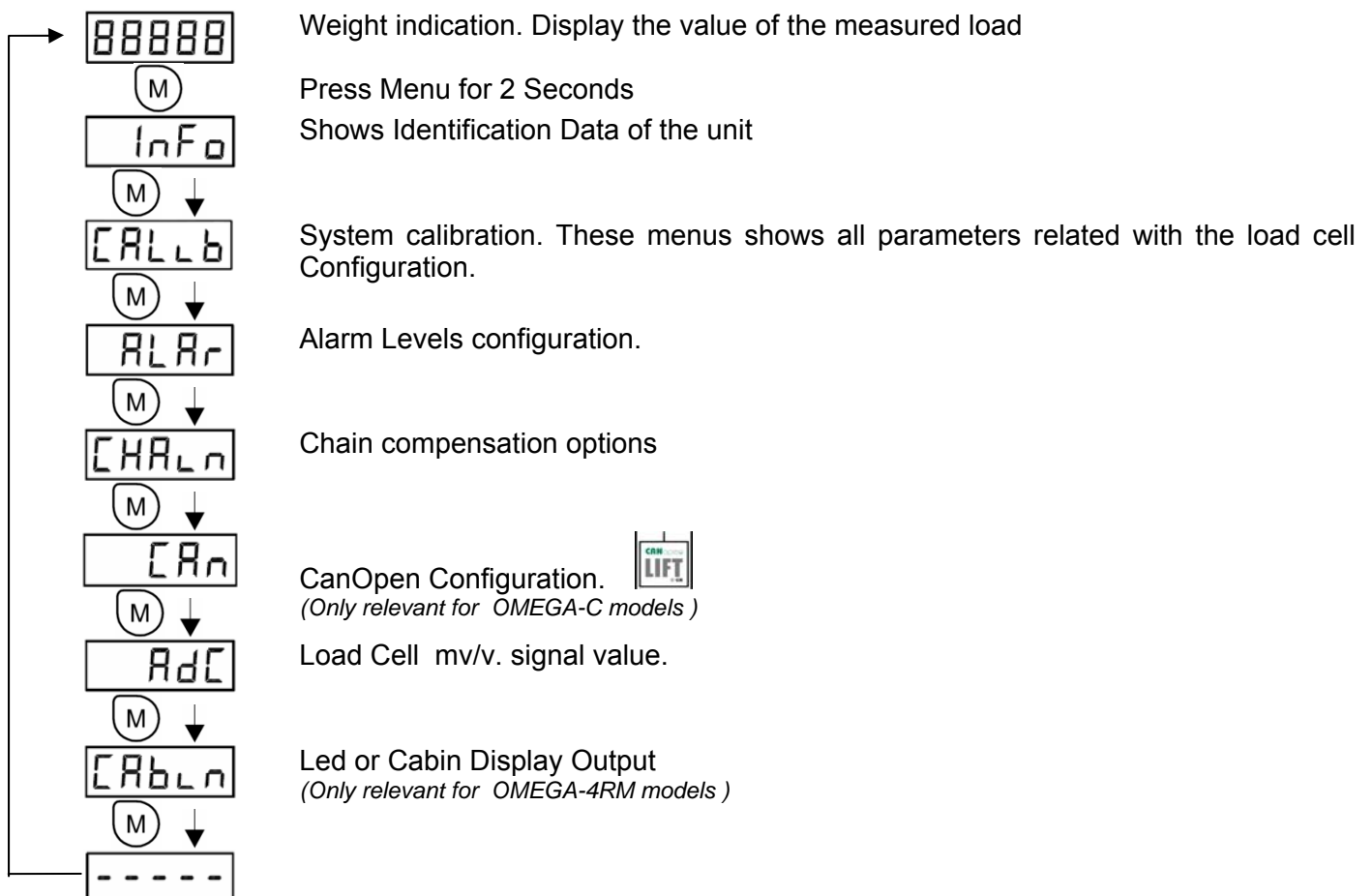



Press  button for 2 seconds to enter and then press it repeatedly to move from a parameter to another. Press it for 2 seconds to exit.



Pressing Menu for 2 seconds inside the internal navigation menu will end the menu navigation and return to Display the value of the measured load

## 5. HOW TO VISUALIZE OR CHANGE PARAMETERS

Once inside any menu and displaying the parameter to be viewed or changed:

- Press  to display the current value.
- Press  to select the parameter to be modify :
- Press  to choose the digit position to change ( Flashing )
- Press  to change the value of the Current Flashing digit position. (if there's no flashing digit, change the value with  key directly)
- Press  twice to save the value.



If  button is not pressed again before display Flashing ends (10 seconds), the parameter value will not be changed.

After any of these operations, the display will show the current parameter.

## 6. DEVICE INFO

All new NG units store some important information in this menu in order to build wireless connections with any remote future unit developed by Dinacell Electronica. All parameters can be read in this submenu.

Submenu InFa

Press to enter

Check value







Enter to modify

InFa	➔	Add	➔	<b>Add:</b> NG Network Address of the unit.
		(M) ↓		
		Id nu	➔	<b>Id nu:</b> Identification number of the unit. Unique identification for each unit.
		(M) ↓		
		EQULP	➔	<b>Equip:</b> Model of unit. Valid Values: <b>OME</b>
		(M) ↓		
		UEr	➔	<b>Ver:</b> Firmware Version of Unit <b>OMEGA<sup>NG</sup></b> Valid Values: 1.00 and above
		(M) ↓		
		U_HAR	➔	<b>V_Har:</b> Hardware Version of Unit <b>OMEGA<sup>NG</sup></b>
		(M) ↓		
		APL	➔	<b>APi:</b> ApiVersion of NG Dinacell Network Valid Values: 100 and above
		(M) ↓		
		VOLT	➔	<b>VOLT:</b> Internal Power supply Voltage of unit <b>OMEGA<sup>NG</sup></b> Valid Values: (around 24 volts )
		(M) ↓		
		rESEt	➔	<b>rESE:</b> Reset all parameters value to Factory defaults. All calibration data will be lost
		(M) ↓		
		----		

## 7. SYSTEM CONFIGURATION

This section describes how to configure the Unit to obtain the best measure accuracy. The configuration is done in **CALCb** Menu.

Press to enter  Check value   Enter to modify

<p><b>CALCb</b> </p> <p><b>nSen</b></p> <p>(M) ↓</p> <p><b>IrEF</b></p> <p>(M) ↓</p> <p><b>UnLts</b></p> <p>(M) ↓</p> <p><b>SuSPE</b></p> <p>(M) ↓</p> <p><b>ZEro</b></p> <p>(M) ↓</p> <p><b>LoAd</b></p> <p>(M) ↓</p> <p><b>CELL</b></p> <p>(M) ↓</p> <p><b>tSen</b></p> <p>(M) ↓</p> <p>---</p>	<p>→ <b>nSen:</b> Number of sensors connected to ropes or cables. If this parameter is not set correctly, the unit will show <b>Err1</b> and alarm relays will be activated.</p> <p>→ <b>IrEF:</b> Initial Reference of the sensors. This operation must be done with the Sensors uninstalled on the ropes.</p> <p><i>Note: It is mandatory to do the irEF operation if Wire Rope Tension balancing is going to be adjusted. If you forget to make this operation or no rope tension equalizing needs to be performed, you can select the option "rese" on IrEF Submenu to make the irEF with sensors installed.</i></p> <p>→ <b>Units:</b> Display Weight units. Available units are Kilos/Pounds</p> <p>→ <b>SusPE:</b> Type of suspension at installation: 1:1 2:1 3:1 4:1</p> <p>→ <b>Zero:</b> Zero point adjustment With empty elevator. Store a Countdown value for Zero and load calibrating parameters</p> <p>→ <b>Load:</b> Well known weight applied inside the elevator to do the weight calibration of the unit. (It is recommended to set up to 60% of the nominal load of the elevator.)</p> <p>→ <b>Cell:</b> Nominal load cell sensibility. This value is calculated when LOAD operation is done. <b>User shouldn't modify this value.</b> ( If this parameter is modified the previous calibration settings will be overwritten)</p> <p>→ <b>tSen:</b> indication of individual Sensor Rope weights. On the display appears the weight in units selected (e.g. <b>100kg</b>) alternating with the Sensor number ( <b>Se 1</b>)</p>
--	--

**Calibration process:**

- 1) Install the control unit with the information of the *INSTALL AND CONNECTIONS* chapter.
- 2) Connect Load Cell to the OMEGA<sup>NG</sup>
- 3) Power up the unit with the correct voltage (see the *ELECTRICAL SPECIFICATIONS* chapter).
- 4) Go to **CALLB** Submenu:
- 5) Detail Calibration Procedure:

Follow next steps to set a precise Load Measuring system

**nSEN** 5.1) Select number of sensor ropes.



**lREF** 5.2) Do and lref "**ALL**" Operation with sensors **not installed** on the ropes.

Note: if your sensors are already installed and you don't need to equalize the rope tension you can select "**rese**" option on lref submenu.

**UnLts** 5.3) Select display measuring units. Available units are Kilograms or Pounds

**SUSPE** 5.4) Select Suspension. By default 1:1 is selected



**ZEro** 5.5) **Zero adjustment:**

- a) Install sensors on the ropes when using SWK, SWR or LCA.
- b) Select Submenu Zero by pressing 
- c) Change countdown value if desire.
- d) Press menu  and display will start flashing
- e) Make sure elevator is empty and confirm operation by pressing  again.
- f) The countdown will start. During this time, the car weight must not change.

**LoAd** 5.6) **Load Point adjustment:** With This function the Unit will be calibrated with the best accuracy.

Put a well known weight into the cabin. Is recommendable a 60% of elevator duty load.

To make the Load point adjustment:

- a) Select Submenu Load by pressing 
- b) Set the value with the total Load added into the elevator.
- c) Press menu  and display will start flashing
- d) Confirm operation by pressing  again.
- e) The countdown will start. During this period of time, the car weight must not change

**CELL** 5.5) This parameter stores the Sensor Sensibility. Cell value is automatically calculated after a Load Point adjustment. If Cell Value is changed, the previous calibrating process will be overwritten.

## 8. ALARMS CONFIGURATION

The alarms values correspond to the load threshold at which each relay change its state.

The relays allows to be configured individually as make or break contact

Alarms are activated when their threshold is exceeded. The Unit OMEGA<sup>NG</sup> has 4 different alarms:

### AL-1 (Full Load, Relay #1):

Change of state when exceeding the load programmed in

### AL-2 (Over Load, Relay #2):

Change of state when exceeding the load programmed in

### AL-3 (Zero Load, Relay #3):

Change of state when falling below the load programmed in

**Note:** *This alarm is active below Alarm3 Threshold.*

### AL-4 (Rope Tension Difference and Slack Rope Tension, Relay #4):

Change of state if any rope has a slack rope tension or if **any rope deviates from the average of all other ropes** at least by the **percentage** programmed in .

The working procedure of the relays as a make or break contact can be changed for each alarm output using the  parameter. **Valid values are (Close) for the operating mode MAKE and (Open) for the operating mode BREAK. Close is a normally closed relay and OPEn is a normally open relay.** Alarm LEDs indicators will be activated when the display measured value overload corresponding alarm level



**Note: LEDs are not related to relay state but alarms levels.**

How to configure alarm settings:

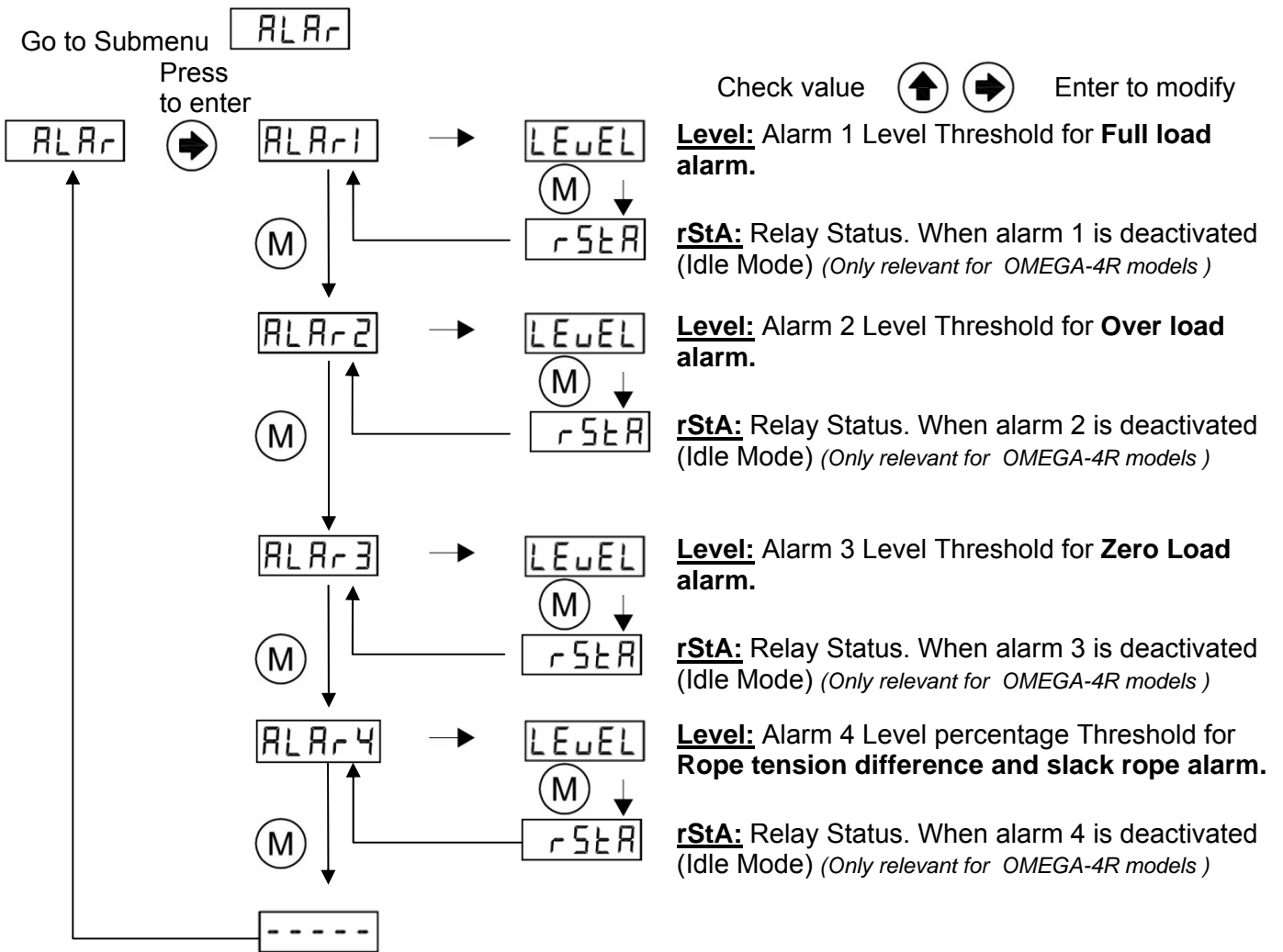

 All Displayed weights and alarm thresholds are shown in selected units. All internal calculations are made in kg, therefore, rounding errors are possible

## 9. CHAIN COMPENSATION

### 9.1. New Chain Compensation

The New Generation of Load Weighing Devices has the newest Software for chain compensation. It offers several options to improve the accuracy to compensate the weight of the chain.

In this Submenu, the user can choose between three options, no compensation, software compensation and hardware compensation.

### 9.2. Submenu Chain

Submenu CHARn

Press  
to enter

Check value ↑ → Enter to modify

CHARn



TYPE

→ **Type:** Type of chain compensation applied. User can choose between hardware compensation, software compensation or none compensation



VALUE

→ **Value:** Max Chain value to compensate. At installation. Valid Values : 0-600



C bot

→ **C Bot:** Chain zero operation at the ground floor



C top

→ **C Top:** Chain load operation at the top floor



C Har

→ **C Har:** Real chain load value compensated by hardware measure in selected units



ChCEL

→ **ChCEL:** Nominal Chain load cell sensibility. This value is calculated when C\_Bot or C\_top operation is done. **User shouldn't modify this value.** ( If this parameter is modified the previous calibration settings will be overwritten)



C Sof

→ **C Sof:** Chain load value compensated by software estimation in selected units



t1

→ **Time 1:** Time to get hold weight before Hold is activated



t2

→ **Time 2:** Time to get hold weight after Hold is deactivated



-----



### 9.3. Chain Compensation Adjust

The NG Series has new advanced chain compensation. To use all the features of new compensation is necessary to adjust some parameters in **CHALn** Menu.

There are two types of compensation.

- **Software chain compensation:** When selected, the unit compensate the chain with hold signal activations/ deactivations.
- **Hardware chain compensation:** When selected, the unit compensate the chain with the on real time weight of the chain. This can be done using the auxiliary Load Cell input for chain compensation and adjusting the **CHALn** parameters for hardware compensation.

**Note:** To deactivate all chain compensations just set Type parameter to **none**.

**TYPE** Set Type to **None** value.

#### 9.3.1. Software Compensation

This function allows compensate the difference of weight between floors produced by the chain. The unit needs the HOLD signal to be active when the doors close to compensate the weight during the elevator movement.

To configure the software compensation:

- **TYPE** Set Type to **SoFT** value.
- **WALWE** Set the estimated weight of the chain. This parameter will be the maximum value compensated by software compensation
- **C50F** In this parameter you can check the value the **OMEGA<sup>NG</sup>** is compensating by software each time the HOLD signal is deactivated

When using software compensation, Auto\_Zero compensation will be activated automatically.

#### 9.3.2. Hardware Compensation

In some installations ( the largest ones), software chain compensations doesn't work perfect due to different friction in the rails between floors, weight changes during long elevator travels, or just any auto\_zero is done cause elevator never stops.

These problems can be solved with Hardware compensation.

It is mandatory to plug an auxiliary Sensor (Load Cell for chain compensation) when hardware compensation is selected. Otherwise Err11 will flash in the display.

Auto\_Zero compensation will be also deactivated automatically

A system Configuration (Point 7) must be done previous to set the Hardware compensation parameters.

- **[TYPE]** Set Type to **Hard** value
- **[C bot]** **Take the elevator to the ground floor** and set C\_Bot To Yes. A Countdown will start.
- **[C top]** **Take the elevator to the Top floor** and set C\_TOP To Yes. A Countdown will start
- **[C HAR]** In this parameter you can check the value the **OMEGA<sup>NG</sup>** is compensating by hardware with the chain load cell

### 9.3.3. Auto-Zeroing Compensation

The Auto\_Zero compensation is designed to automatically remove small measurement error lower than parameter **[URLUE]**

The Auto-Zero function will happen whenever the **OMEGA<sup>NG</sup>** measures a static offset of  $\pm$  **[URLUE]** for a period of at least 120 seconds. During this time the measured load must not change by more than 20kg. The **OMEGA<sup>NG</sup>** applies an internal compensation value equal to the inverse value of the currently measured offset.

The Auto\_Zero compensation value is stored in internal memory. After power cycling the measure in the display will be the same. To eliminate the Auto\_Zero compensation, a Zero operation should be done.

## 10. ADDITIONAL FUNCTIONS

### 10.1. Hold function

During the elevator travel, the measured loads can heavily fluctuate due to friction in the rails, loads movements, etc. When a voltage in the range 24-230V (DC or AC) is applied in this input, the unit holds the last stable measure of weight acquired.

The voltage must be applied when the doors close and it must be removed as the doors open. This ensures that the movement of the cabin will not affect the weighing process and therefore, no alarms or relay will be activated during elevator travel.

To improve the hold of a stable measure two parameters have been added at CHAIN menu  and .

As some installations sets the HOLD input at the same time it closes the doors, sometimes the last measure obtained is not as stable as desire. The same issue can happen when removing the HOLD input and the doors Open.

- Time in tenth of seconds to take the measure before the hold. Signal is active.
- Time in tenth of seconds to update the measure after the hold. Signal is released.

**Note:** With T<sub>1</sub> = 10 and T<sub>2</sub> = 15:

If hold signal is activated, then, the OMEGA<sup>NG</sup> will take as a valid measure the last stable weight value that was stored 1 second before hold was activated. Then when hold is released the first stable value will be taken 1.5 seconds after the hold signal is deactivated.

This option offers great flexibility to resolve problems in some critical installations.

### 10.2. Analog output *(Optional)*

This unit is provided with two analog outputs (Voltage and current output). Both Outputs are active and operative at same time.

This function reflects the sensors signal over the range between ZERO and the value sets for **ALARM1 (full load)**:

Output	Range	
0-10 volts (0-5 Optional)	When weight ≤ 0kg (empty elevator)	0 V
	When weight ≥ ALARM1 (elevator at full load)	10 V (5V Optional)
4-20 mA	When weight ≤ 0kg (empty elevator)	4 mA
	When weight ≥ ALARM1 (elevator at full load)	20 mA

Example: Once the system is completely configured, if ALARM1 is set to 400 kg and if unit measures 200kg then;

- 0-10V Output will be 5V.
- 4-20mA output will be 12mA.

**10.3. Cabin Display** *(Optional)*

It provides two types of output depending on the CDISP parameter:

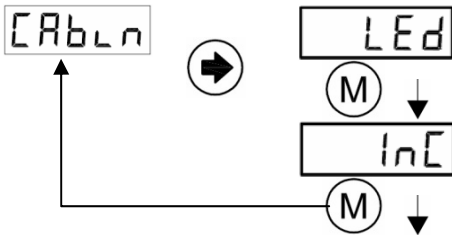
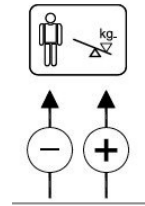

- **LED Indicator:** Under overload it will be an intermittent voltage of 5V (max. 75mA) with the polarity shown in the figure.
- **LED Incremental** Progressive display MB-D (two wire connection without polarity)

**11. CanOpen PARAMETERS** *(Only relevant for OMEGA-C models )*



Dinacell electronic is member of the CiA ( Can In Automation ),  
**Vendor-ID 00000361**



**OMEGA<sup>NG</sup>-C** accomplish with the CanOpen-Lift CiA 417 profile.

Some important CanOpen Parameters can be modified from this Submenu as, Baud rate and Node ID. Weigh change detection is a threshold that will send a PDO message when the weight change overpasses the value.

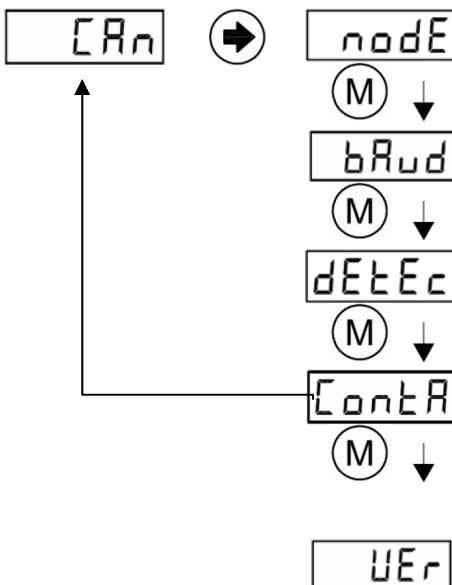

- **Node Id:** Node Id of the CanOpen Load Weighing Device
- **Baud Rate:** Baud Rate of the CanOpen Device. 125kb or 250kb Supported for the 417 Profile.
- **Detection of weight change:** Units required for detecting a change of weight in the cabin and send a Can Message by load changed. (1,2,5,10,20,25,50,100,250)
- **Door Contact:** If a Car Door Unit is present at the installation, the **OMEGA<sup>NG</sup>-C** can Read the Door status just setting this parameter to “Yes”. When the Door closes the Measure on the Display is **Hold** and it will not change until the door Opens.
- **CanOpen Version supported:** Actual version supported 2.0.0

- **CanOpen Specifications**

<b>FEATURES</b>	
<b>NMT</b>	NMT Slave
<b>Error Control</b>	Node guarding Life guarding Heartbeat consumer
<b>Boot-up</b>	Yes
<b>Node ID range</b>	From 1 to 127
<b>Node ID</b>	Proprietary LMT-services Keyboard
<b>CanOpen bit-rates</b>	10 kbit/s 20 kbit/s 50 kbit/s 125 kbit/s 250 kbit/s 500 kbit/s 1000 kbit/s
<b>Type of bit-rate adjustment</b>	Proprietary LMT-services Keyboard
<b>RPDOs</b>	1
<b>TPDOs</b>	1
<b>PDO modes</b>	Synchronous (cyclic) Synchronous (acyclic) Event-triggered Remotely-requested Triggered by event-timer
<b>PDO linking</b>	Yes
<b>PDO mapping</b>	Static
<b>SDO server</b>	1
<b>SDO client</b>	No
<b>Emergency Producer</b>	Yes
<b>Emergency Consumer</b>	Yes
<b>Sync Producer</b>	No
<b>Sync Counter</b>	No
<b>Time stamp</b>	No
<b>Additional Functions</b>	None
<b>Supported application layer</b>	CiA 301 V 4.2
<b>Supported Frameworks</b>	CiA 303 V 1.3
<b>Device Profiles</b>	CiA 417: CanOpen application profile for lift control systems V2.0.0.0

## 12. ERROR CODES AND TROUBLESHOOTING

When the unit detects some anomaly it will show an error code from the following table:

	Error description	Action
<code>Err1</code>	Load cell is not properly connected, or its cable is damaged. <b>Err1</b> is shown alternating with the Sensor number ( Se-1,Se-2, etc..)	Check the indicated sensor connection.
<code>Err2</code>	Negative overflow. The load cell is giving a too high negative signal.	Check the load cell connection. It should be no negative charge.
<code>Err3</code>	Positive overflow. Load cell is holding a higher load than its nominal value.	Change the load cell by another with higher nominal load.
<code>Err6</code>	Loss of data in memory. <b>Notice:</b> When this error appears, relays will change to ACTIVATE state.	The unit must be reset to its default values
<code>Err7</code>	Load cell with very low sensibility. The unit was not properly adjusted or load cell has a low nominal value.	Adjust the zero and Load again. Change the load cell by another with lower nominal load.
<code>Err11</code>	Load cell is not properly connected, or its cable is damaged, or wrong number of sensors set in parameter <b>nSens</b> .	Check the chain load cell connection... If no Hardware chain compensation desired, change <b>Type</b> parameter at menu <b>chain</b> to <b>None</b> or <b>soft</b>



**Important:** When an error appears, all alarms are activated and the elevator remains blocked.

### RESTORING THE FACTORY SETTINGS (Only in case of configuration problems)

Just go to menu `InFd` and set `rESEt` option to **yes**:

## 13. ELECTRICAL SPECIFICATIONS

Power supply characteristics	Short-circuitable. It is not necessary to replace any fuse.
Nominal voltage	10-40 Vdc
Maximum current	<200mA
Relays Contacts (Nominal Switching Capacity)	4 Relays: 250VAC / 3A - N.O.
HOLD Input	24V-230V AC/DC
Box	IP-50 V0 fireproof plastic.

## 14. NG CONECTION



All New Dinacell Units have a special feature called NG Connection (New Generation connections)

The main function of the NG connection is to connect to android Smart phones for Unit calibration, and reading Pen Drives for software updating.

### 14.1. Wifi NG Connection

To use all advanced features of NG Connection, user needs to connect the **WRCT<sup>NG</sup>** adapter to the unit **OMEGA<sup>NG</sup>** and **Dinacell TOOLS Application software** must be installed in a smart Phone or Laptop.

Users can download the Dinacell Application “**Weighing NG**” from Google Play Store market or from Apple Store.

With the New **WRCT<sup>NG</sup>** adapter connected to the NG Connection of the **OMEGA<sup>NG</sup>**, users can:

- Get all parameter values of the unit in real time.
- Calibrated the unit without using the key board.
- Test the installation performance.
- Make studies of the measures in the installation to adjust rope tensions, guides, detect friction problems during travels.
- Save all Calibrating parameters data in a Pdf report.
- Send reports by mail.
- Stores all installation calibrations in a single phone.
- And so on, cause software is in continuous development.

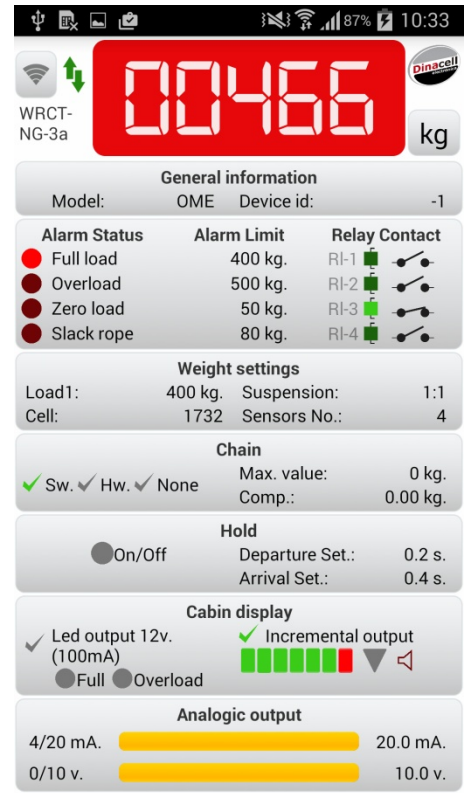

### 14.2. Firmware Update

It is possible to update the firmware of any NG Device using the NG connection and a Flash Pen drive.

Follow next steps to enter in Boot loader mode for firmware updating:

- Copy new firmware (.CYP file) in the Flash Pen drive.
- Plug the Pen drive in the auxiliary USB cable adapter from USB to Mini USB.
- Switch off the unit **OMEGA<sup>NG</sup>** by removing the power supply.
- Press **(M)** key and **apply power to the unit with the key pressed**. ERR LED will flash each second, and 5 Digits display will be switched off.
- Plug the Mini USB cable on the NG connector. STA LED Will be ON and ERR LED will Flash Faster (each 0.5 second)
- Be patient and Wait until unit reboots. The process can take up to a minute.
- When programming ends the Unit Will reboot automatically.

## 15. WIRE ROPE TENSION ADJUSTMENT

This section explains how to check the tension of all wire ropes of the installation. All ropes should carry the same tension. Equally tensioned ropes improve ride quality and extend life of ropes and sheaves.

Nowadays most elevator systems have multiple wire ropes attached to the cabin and counterweight. These ropes normally run over a traction sheave or pulley just to move the cabin up and down the hoistway.

When some ropes have more tension than others, the ropes with lower tension will slide over the pulley and can produce a crown groove wear at the sheave. It is possible to detect this wear by rope slapping, vibrations on the cables, or metal dust on the pulley.

Normally, the system works better if all the ropes have similar tension (about  $\pm 5\%$ ) of the nominal load of the installation.

Although some installers manage to adjust the rope tension manually just touching the ropes or just tuning the installation plucking each rope as a harp string, the best way to do this operation is measuring the load on all the ropes and displaying it in real time.

Usually load weighing devices manufacturers have dedicated and expensive tools to do these operations.

But the **OMEGA<sup>NG</sup>**, can be used not only as a good Load Weighing device but as an additional low cost rope tension balancing tool also.

And as the unit will be installed for life you will have a permanent tool to adjust wire rope tension and detect slack ropes at the installation in real time.

### 15.1 Wire Rope Tension checking Tool

The only tool needed to adjust the wire rope tension is the **WRCT<sup>NG</sup> dongle** and a Smartphone, a tablet or a laptop. Then from the rope tension screen you will visualize the load of each rope in real time. Now it is possible to adjust the tension of each rope to make them equal.

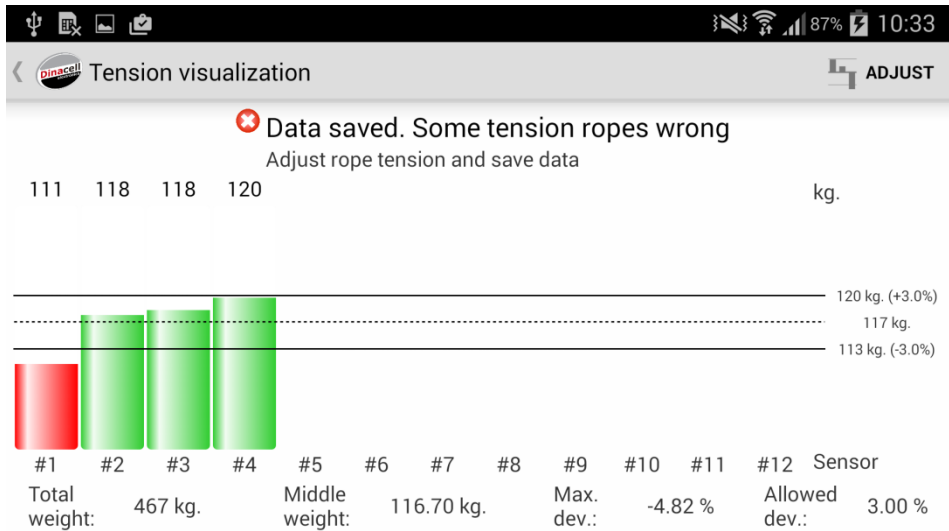

## 15.2 Assistance to the wire rope tension adjustment

With this assistant tool you will be guided to adjust each rope with the adequate load just to accomplish the desired target. To enter this mode just push **ADJUST** label

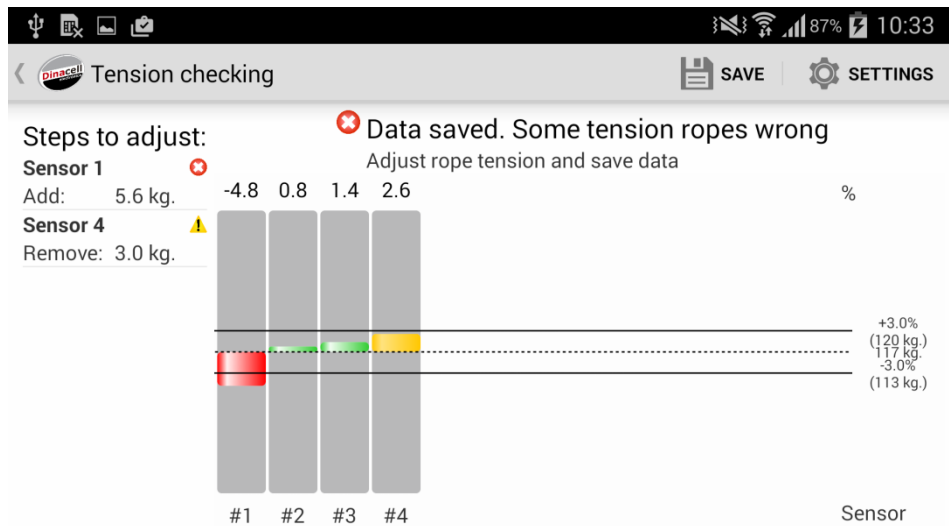

Following the suggested steps, you can apply the precise load to each rope to perform the whole "wire rope tension" process, just in a few minutes.

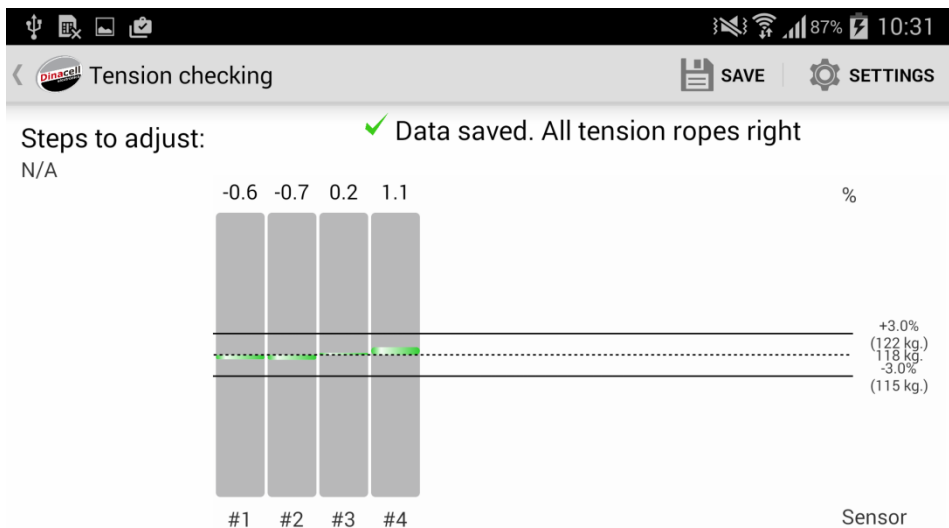

Now, you can check the final result of the adjustment process.

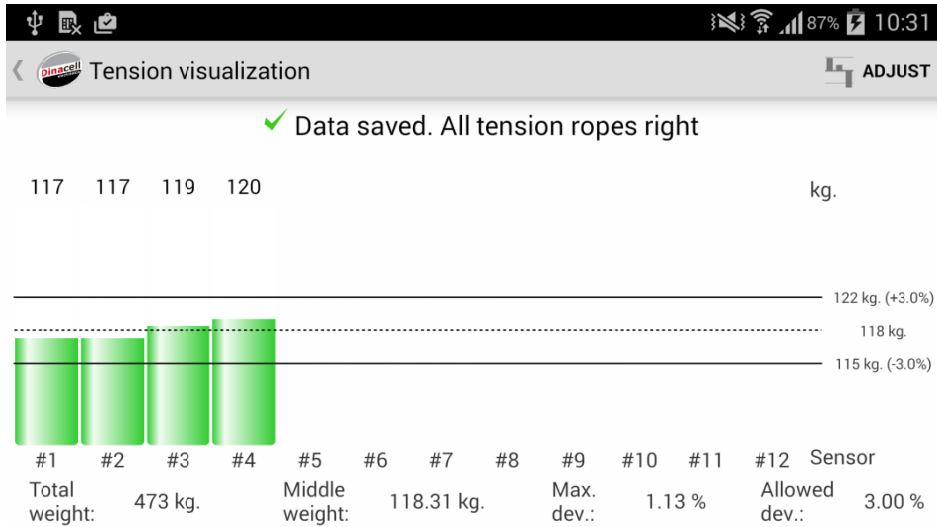

You can save all your installations data on your Smartphone, tablet or laptop. You can save as many installations as you desire (the only limitation is the memory of each device). Sending reports by mail or create your own PDF reports are also possible from the tool.

### Laptop Configuration Software:

Same operations can be done from a laptop or any computer with WIFI connection.

**TOOLS NG**

Device Information

Model: VK-OMEGA  
Device Id: 25673  
Net address: 125  
Voltage: 28.15

01330 kg

Additional Information

API version: 1.03  
Software version: 1.02  
Hardware version: 21.02  
Label: OME  
Refresh weight frequency: 20

Weighing

Units of measure: kg  
Suspension: 1:1  
Load value: 100 kg  
Cell value: 1728  
Number of alarms: 4  
Number of relays: 4

Chain and Hold

Compensation type: Ninguna  
Hold time to departure: 0.2 s  
Hold time to arrival: 0.4 s

Sensors

Number of sensors:	12
Total weight:	1328.77 kg
Middleweight:	110.73 kg
Maximum deviation:	26 kg
Allowable deviation:	5 %

Sensors: #1 (94), #2 (112), #3 (127), #4 (130), #5 (137), #6 (127), #7 (109), #8 (102), #9 (105), #10 (103), #11 (108), #12 (105)

## 16. QUICK CONFIGURATION GUIDE

### • Parameters checking or modification

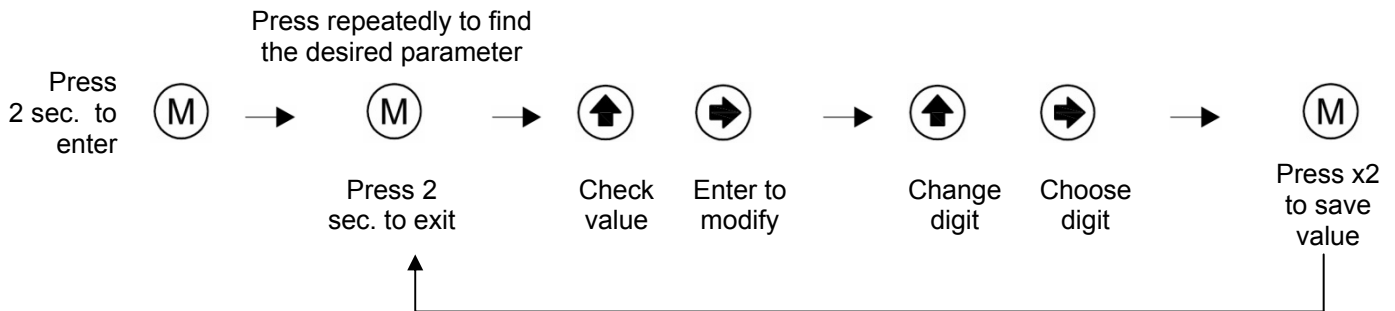

### • Quick System configuration

1. Install the **OMEGA<sup>NG</sup>** in an appropriate location.
2. Connect all sensors to the unit and relay outputs if necessary( do not install sensors on the ropes yet)
3. Go to **[CALCb]** submenu
4. Set the number of sensor (ropes) **[nSEN]** of the installation.
5. Do and **[IrEF]** operation for **all** sensors.
6. Set **[UnLbS]** to kilo or Pounds
7. Set the Suspension Factor **[SuSPE]**.
8. **Install the sensor on the Ropes.**
9. Empty the elevator and set the countdown value for calibrating operations. Confirm the value **[ZEr0]** for Zero Operation. A countdown will start.
10. Set a well-known weight inside the cabin and adjust **[LoAd]** parameter with the weight added. A countdown will start.
11. Set the alarms thresholds **[LEuEL]** for each alarm and the activation state **[rStA]** for each relay.
12. If chain compensation is desired, select the type **[tYPE]** of compensation you want to use.
  - If **software** compensation is selected then set the estimated weight value in Menu Chain **[CHAIn] → [VALUE]** option.
  - If **Hardware** compensation is selected then an **[C bot]** operation must be down at the bottom floor, and afterwards an **[C top]** operation should be done at the top floor of the installation. (Remember to do both operations with no weight inside de cabin).



**Copyright 2014 by Dinacell Electrónica s.l.**  
Pol. Ind. Santa Ana C / Torno Nº 8  
28522-Rivas Vaciamadrid - Madrid  
Tel.: +34 91 300 14 35 Fax.: +34 91 300 1645  
[www.dinacell.com](http://www.dinacell.com)

Ref.: 8792-06  
09/03/16